

LOW POWER, LOW DROPOUT
MIDDLE CURRENT VOLTAGE REGULATORS

DESCRIPTION

The SK6206 series are precise, low power consumption, high voltage; positive voltage regulators manufactured using CMOS and laser trimming technologies. The series provides large currents with a significantly small dropout voltage. The SK6206 consists of a current limiter circuit, a driver transistor, a precision reference voltage and an error correction circuit. The series is compatible with low ESR ceramic capacitors. The current limiter's foldback circuit also operates as a short protect for the output current limiter and the output pin. Output voltage can be set internally by laser trimming technologies. It is selectable in 100mV increments within a range of 1.2V to 5.0V. SOT-89-3, SOT-23-3, SOT353 and SOT23-3B packages are available.

FEATURES

I	Output Voltage Range	1.2V to 5.0V (selectable in 100mV steps)
I	Highly Accurate	$\pm 2\%$
I	Dropout Voltage	160mV @ 100mA (3.0V type)
I	Low Power Consumption	2 μ A (TYP.)
I	Maximum Output Current	300mA ($V_{in} \geq V_{out} + 1V$)
I	Internal protector	current limiter and short protector
I	Small packages	SOT-89-3, SOT-23-3, SOT23-3B, SOT353 and other required

APPLICATIONS

- I Battery powered equipment
- I Reference voltage sources
- I Cameras, Video cameras
- I Mobile phones
- I Communication tools

PACKAGE

- I SOT-89-3
- I SOT-23-3, SOT23-3B
- I SOT353
- I Other required

BLOCK DIAGRAM

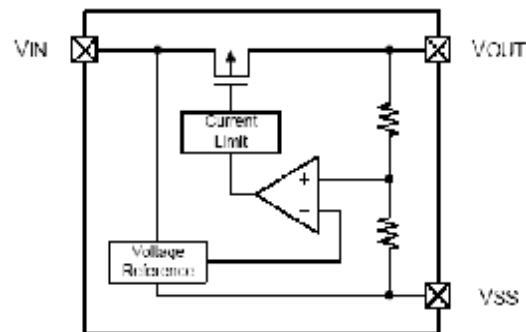

Figure 1

ABSOLUTE MAXIMUM RATINGS

PARAMETER	SYMBOL	MAXIMUM RATING		UNIT
Input Voltage	V_{IN}	$V_{SS}-0.3 \sim V_{SS}+6$		V
Output Current	V_{OUT}	$V_{SS}-0.3 \sim V_{IN}+0.3$		
Power Dissipation	P_D	SOT-23-3, SOT23-3B	250	mW
		SOT353	250	
		SOT-89-3	500	
Operating Ambient Temperature	T_{opr}	$-40 \sim +85$		°C
Storage Temperature	T_{stg}	$-40 \sim +125$		

Caution: The absolute maximum ratings are rated values exceeding which the product could suffer physical damage. These values must therefore not be exceeded under any conditions.

Electrical Characteristics

Item	Symbol	Condition	MIN	TYP	MAX	UNIT	CIRCUIT
Output Voltage	$V_{OUT(E)1}$	$V_{IN} = V_{OUT(S)} + 1.0 \text{ V}$, $I_{OUT} = 40 \text{ mA}$	$V_{OUT(S)} \times 0.98$	$V_{OUT(S)}$	$V_{OUT(S)} \times 1.02$	V	1
Output Current	I_{OUT}	$V_{IN} \geq V_{OUT(S)} + 1.0 \text{ V}$	300^{*5}	—	—	mA	1
Dropout Voltage	V_{drop}	$I_{OUT} = 100 \text{ mA}$	$1.5 \text{ V} \leq V_{OUT(S)} \leq 2.5 \text{ V}$	—	0.20	0.28	V
			$2.6 \text{ V} \leq V_{OUT(S)} \leq 3.3 \text{ V}$	—	0.16	0.24	
			$3.4 \text{ V} \leq V_{OUT(S)} \leq 5.0 \text{ V}$	—	0.12	0.20	
Line Regulations	$\frac{\Delta V_{OUT1}}{\Delta V_{IN} \cdot V_{OUT}}$	$V_{OUT(S)} + 0.5 \text{ V} \leq V_{IN} \leq 5.5 \text{ V}$ $I_{OUT} = 80 \text{ mA}$	—	0.05	0.3	%/V	1
Input Voltage	ΔV_{OUT2}	$V_{IN} = V_{OUT(S)} + 1.0 \text{ V}$ $1.0 \text{ mA} \leq I_{OUT} \leq 80 \text{ mA}$	—	20	40	mV	
Output Voltage Temperature Characteristics	$\frac{\Delta V_{OUT}}{\Delta Ta \cdot V_{OUT}}$	$V_{IN} = V_{OUT(S)} + 1.0 \text{ V}$, $I_{OUT} = 10 \text{ mA}$ $-40^\circ\text{C} \leq Ta \leq 85^\circ\text{C}$	—	± 100	—	ppm/°C	
Supply Current	I_{SS1}	$V_{IN} = V_{OUT(S)} + 1.0 \text{ V}$	—	2	—	μA	2
Input Voltage	V_{IN}	—	1.8	—	6	V	—
Ripple-Rejection	RR	$V_{IN} = V_{OUT(S)} + 1.0 \text{ V}$, $f = 1.0 \text{ kHz}$ $V_{rip} = 0.5 \text{ V}_{rms}$, $I_{OUT} = 80 \text{ mA}$	—	40	—	dB	1
Short current	I_{short}	$V_{IN} = V_{OUT(S)} + 1.5 \text{ V}$,	—	30	—	mA	1
Current Limiter	I_{lim}	$V_{IN} = V_{OUT(S)} + 1.5 \text{ V}$,	—	380	—	mA	1

TEST CIRCUITS

Circuit (1)

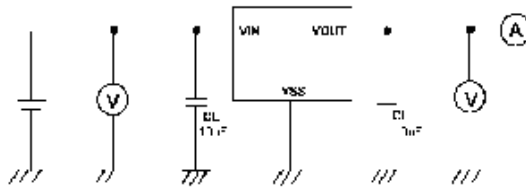

Circuit (2)

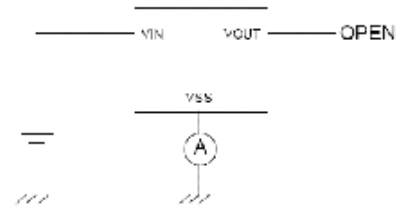

TYPICAL APPLICATION CIRCUIT

1、Basic circuit

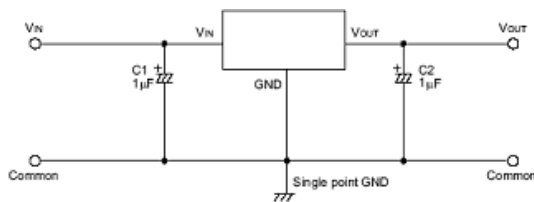

2、High output current positive voltage regulator

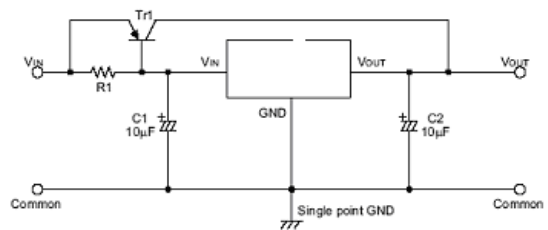

3、Circuit for increasing output voltage

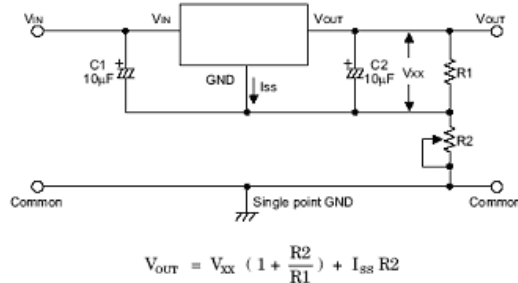

4、Circuit for increasing output voltage

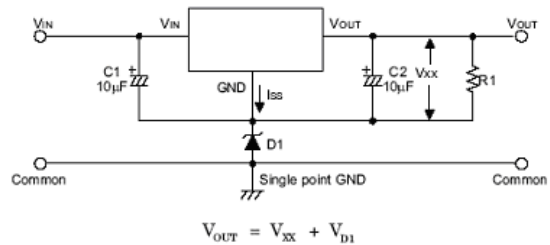

5、Constant current regulator

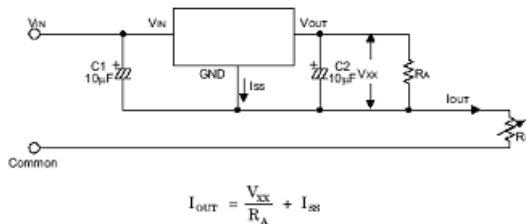

6、Dual supply

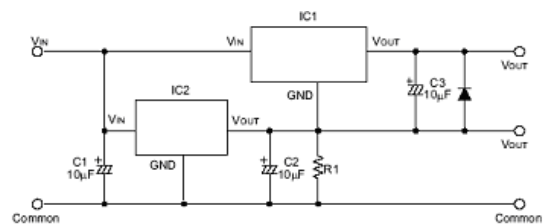

Caution The above connection diagram and constant will not guarantee successful operation. Perform thorough evaluation using the actual application to set the constant.

Application Conditions

Input capacitor (CIN): 1.0µF or more

Output capacitor (CL): 0.1 µF or more (tantalum capacitor)

Caution A general series regulator may oscillate, depending on the external components selected. Check that no

oscillation occurs with the application using the above capacitor.

■ TYPICAL PERFORMANCE CHARACTERISTICS (3.0V output)

1. Output Voltage vs. Output Current

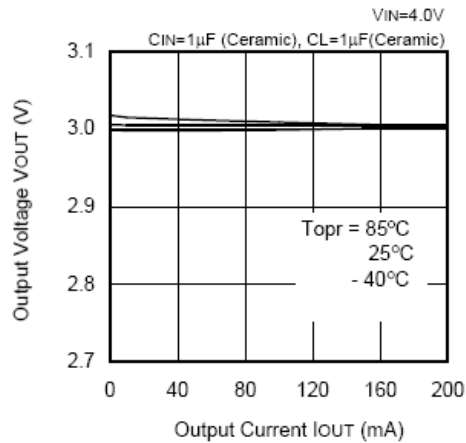

2. Output Voltage vs. Input Voltage

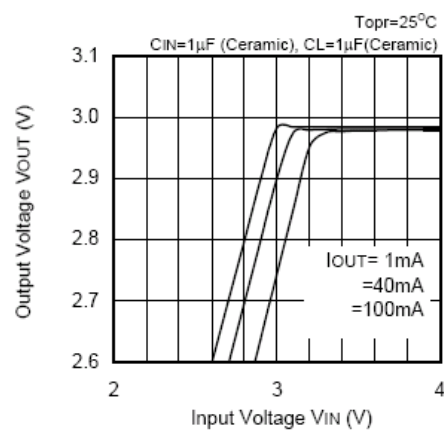

3. Dropout Voltage vs. Output Current

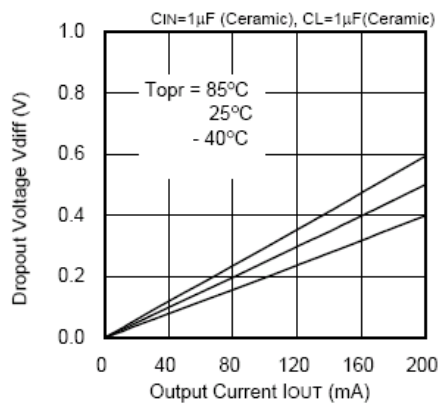

4. Dropout Voltage vs. Output Voltage

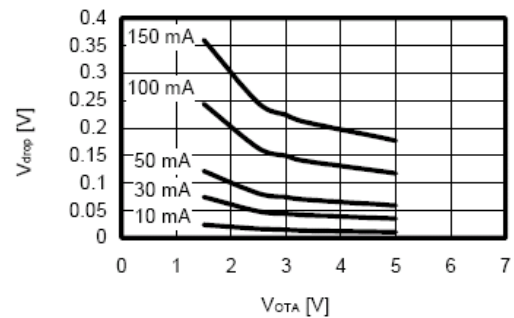

5. Output Voltage vs. Ambient Temperature

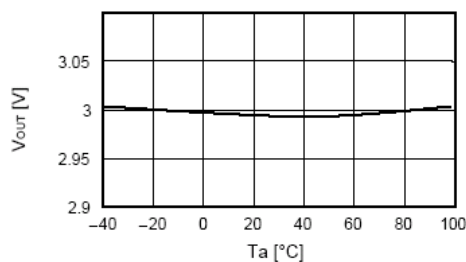

6. Ripple Rejection Rate

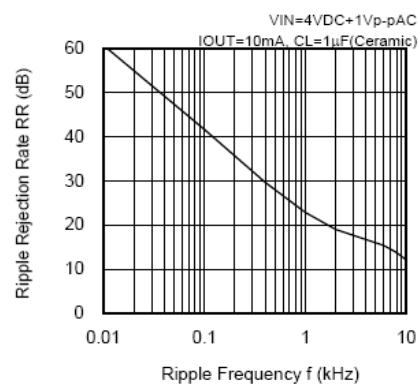

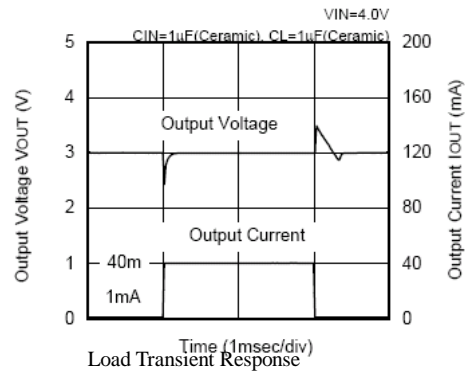
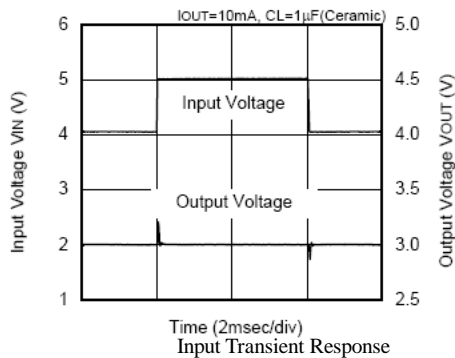

ORDERING INFORMATION

SK6206P①②③④⑤

DESIGNATOR	SYMBOL	DESCRIPTION
① ②	Integer	Output Voltage: e.g. ① =3, ② =0 \Rightarrow 3.0V
③	2	Accuracy: within $\pm 2\%$
④	M	SOT-23
	P	SOT-89
	K	SOT353
	V	SOT23-3B
⑤	R	Embossed Tape: Standard Feed
	L	Embossed Tape: Reverse Feed

MARKING RULE

SOT-23, SOT23-3B & SOT-89

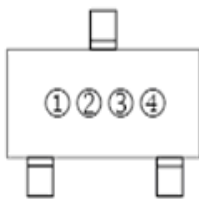

SOT23-3B(TOP VIEW)

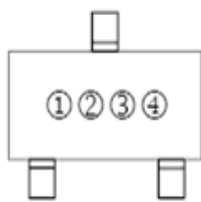

SOT-23 (TOP VIEW)

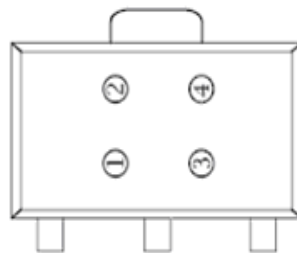

SOT-89 (TOP VIEW)

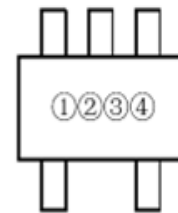

SOT353 (TOP VIEW)

① Represents product series

SYMBOL	PRODUCT SERIES
B	SK6206Pxxxxx

② ③ Represents the Output Voltage

symbol	Output voltage (V)	symbol	Output voltage (V)	symbol	Output voltage (V)	symbol	Output voltage (V)
01	-	16	1.6	31	3.1	46	4.6
02	-	17	1.7	32	3.2	47	4.7
03	-	18	1.8	33	3.3	48	4.8
04	-	19	1.9	34	3.4	49	4.9
05	-	20	2.0	35	3.5	50	5.0
06	-	21	2.1	36	3.6	-	-
07	-	22	2.2	37	3.7	-	-
08	-	23	2.3	38	3.8	-	-
09	-	24	2.4	39	3.9	-	-
10	-	25	2.5	40	4.0	-	-
11	-	26	2.6	41	4.1	-	-
12	1.2	27	2.7	42	4.2	-	-
13	1.3	28	2.8	43	4.3	-	-
14	1.4	29	2.9	44	4.4	-	-
15	1.5	30	3.0	45	4.5	-	-

④ Represents the assembly lot no.
0~9, A~Z repeated (G, I, J, O, Q, W excepted)

■ PIN CONFIGURATION

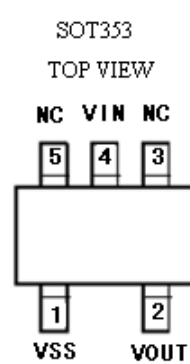
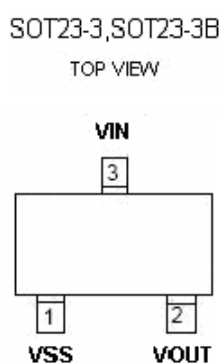
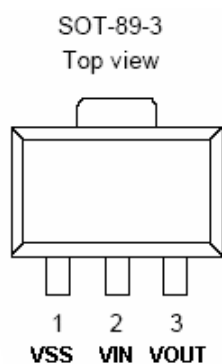

Remark Please contact the Natlinear marketing department for other packages.

PACKAGING INFORMATION

SOT-89-3

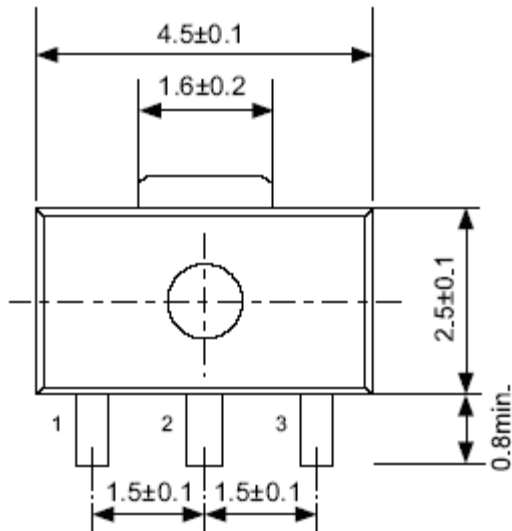

SOT23-3/SOT23-3B

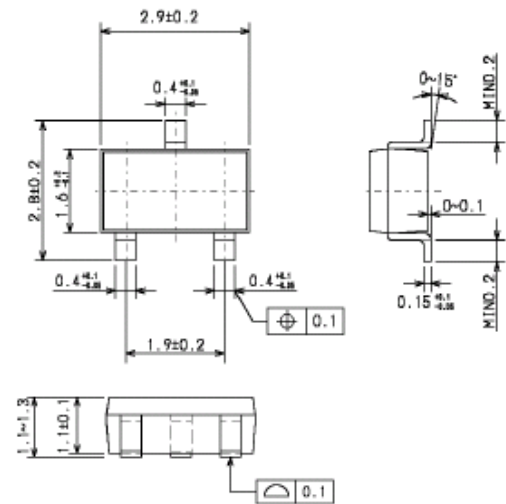

SOT353

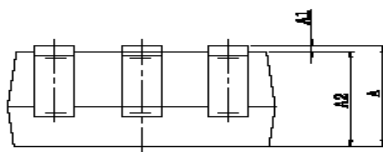
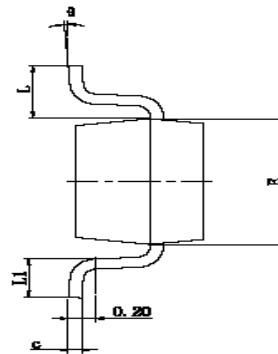
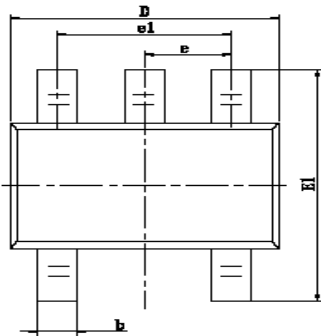

Symbol	Dimensions In Millimeters		Dimensions In Inches	
	Min	Max	Min	Max
A	0.900	1.100	0.035	0.043
A1	0.000	0.100	0.000	0.004
A2	0.900	1.000	0.035	0.039
b	0.150	0.350	0.006	0.014
c	0.080	0.150	0.003	0.006
D	2.000	2.200	0.079	0.087
E	1.150	1.350	0.045	0.053
E1	2.150	2.450	0.085	0.096
e	0.650 TYP		0.026 TYP	
e1	1.200	1.400	0.047	0.055
L	0.525 REF		0.021 REF	
L1	0.260	0.460	0.010	0.018
θ	0°	8°	0°	8°